

Kensington®

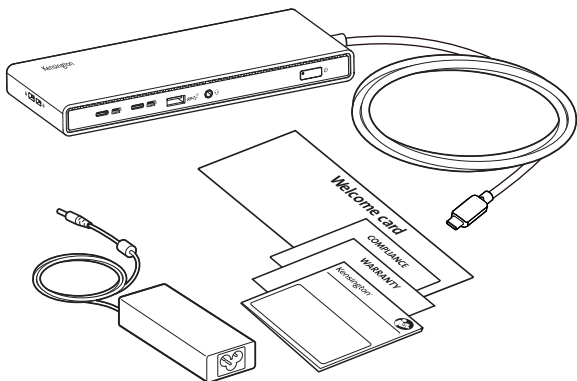

SD4842P USB-C® Triple Video Driverless Dock



NA



EU



AU / CN / JP



IN



[kensington.com/register](https://www.kensington.com/register)

1

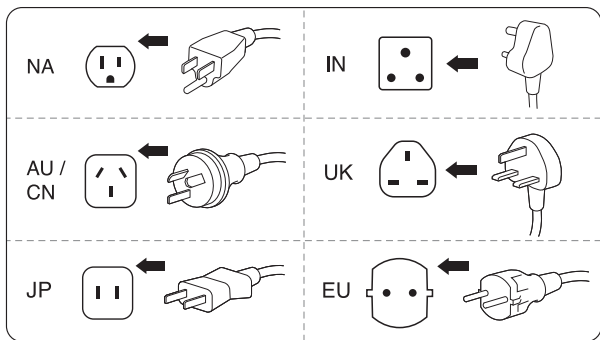
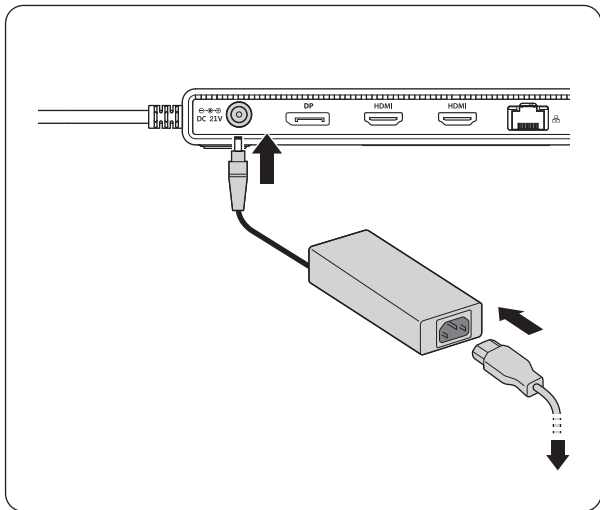

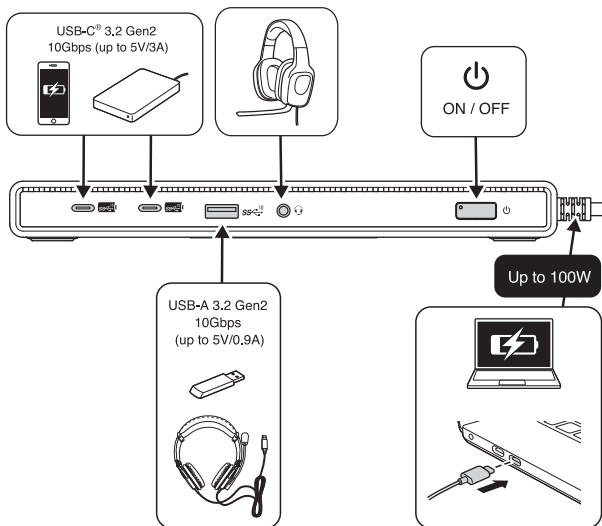

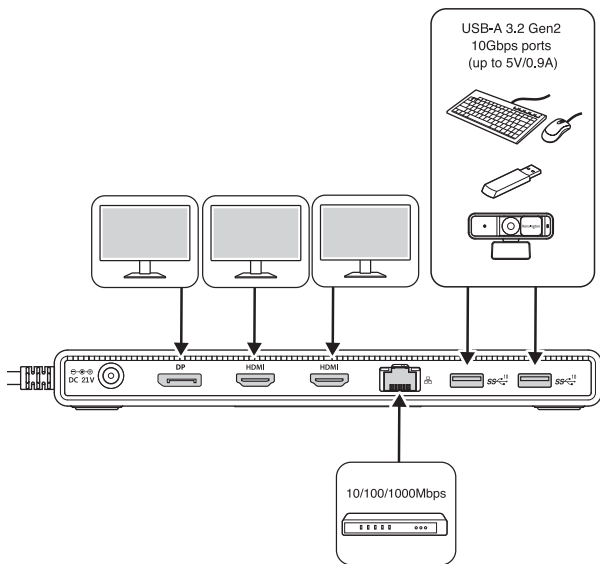

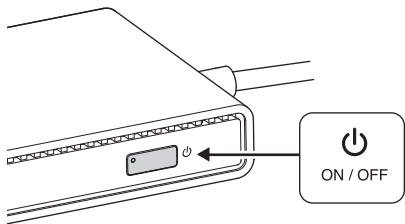

3



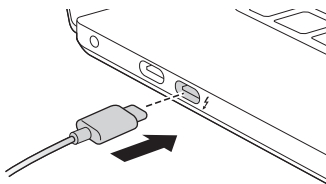
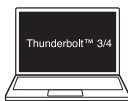

a

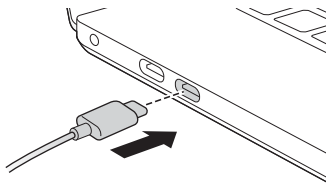
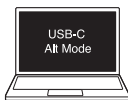





b



4

			
Thunderbolt™ 3* / Thunderbolt™ 4* / USB4* / USB-C® Alt Mode with DP1.4 HBR3 DSC enabled (Windows)	Up to 8K @ 30Hz	Up to 4K @ 60Hz	Up to 4K @ 30Hz
USB-C® Alt Mode with DP1.4 HBR3 with DSC disabled (Windows)	Up to 4K @ 60Hz	Up to 4K @ 30Hz	Up to 1080p @ 60Hz

			
Thunderbolt™ 3* / Thunderbolt™ 4* / USB4* / USB-C® Alt Mode with DP1.4 HBR3 DSC enabled (Windows)	Up to 1080p @ 240Hz	Up to 1080p @ 120Hz	Up to 1080p @ 120Hz

Sold separately

1

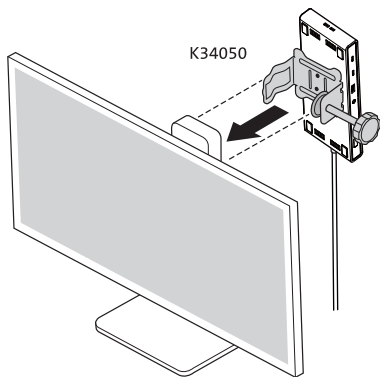

2

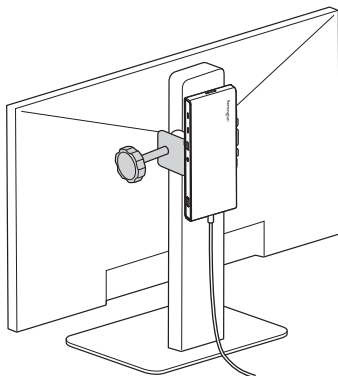

Sold separately

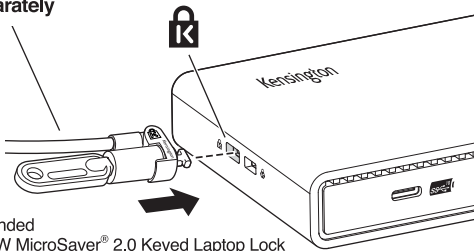

Recommended
K65020WW MicroSaver® 2.0 Keyed Laptop Lock

Sold separately

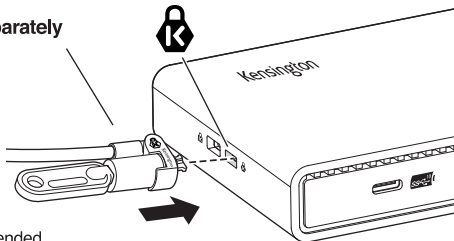

Recommended
K65021WW Slim NanoSaver® 2.0 Keyed Laptop Lock

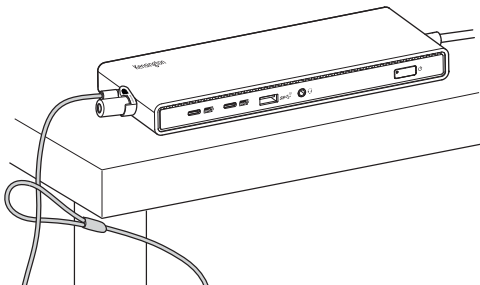



www.kensington.com/support

Kensington® is a registered trademark of ACCO Brands. All other registered and unregistered trademarks are the property of their respective owners. Windows is a registered trademark of Microsoft Corporation in the U.S. and/or other countries.

© 2023 Kensington Computer Products Group, a division of ACCO Brands.

Patents: <https://www.accobrand.com/patents/>

この装置は、クラスB機器です。この装置は、住宅環境で使用することを目的としていますが、この装置がラジオやテレビの受信機に近接して使用されると、受信障害を引き起こすことがあります。

取扱説明書に従って正しい取扱いをして下さい。

VCCI - B

